



**DESCH**



**IPP**

## Oznaczenia / Marks / Bezeichnungen

	Symbol Symbol Symbol		Ilość kartonów na paletcie Number of cartons per pallet Kartonstückzahl je Palette		Ilość worków na paletcie Number of bags per pallet Stückzahl Beutel je Palette
	Pojemność Contents Volumen		Waga palety z kartonami Weight per pallet with cartons Palettengewicht mit Kartons		Ilość worków w kartonie Number of bags per carton Stückzahl der Beutel je Karton
	Średnica Diameter Durchmesser		Ilość na paletcie Number per pallet Stückzahl je Palette		Tace transportowe Transport trays Transportplatten
	Wysokość Height Höhe		Waga palety z doniczkami Pallet weight with pots Palettengewicht mit Töpfen		Ilość i rozmiar otworów Number and dimension of holes Anzahl und Abmessungen der Löcher
	Średnica dna Base diameter Durchmesser Boden		Ilość doniczek na paletcie Number of pots per pallet Stückzahl der Töpfe je Palette		Ilość tac na paletcie Number of trays per pallet Stückzahl der Transportplatten je Palette
	Kąt nachylenia ścian Side inclination Neigungswinkel		Waga palety z doniczkami Pallet weight with pots Palettengewicht mit Töpfen		Wymiary palety Pallet dimensions Palettenabmessungen
	Waga jednostkowa Unit weight Stückgewicht		Wymiary palety Pallet dimensions Palettenabmessungen		Waga palety z tacami Pallet weight with trays Palettengewicht mit Transportplatten
	Ilość otworów w dnie Number of base holes Anzahl der Bodenlöcher		Wymiary palety Pallet dimensions Palettenabmessungen		Ładowność Capacity Belastbar bis
	Ilość w kartonie Number per carton Stückzahl je Karton		Ilość sztuk w worku Number per bag Stückzahl je Beutel		
	Waga kartonu Weight per carton Kartongewicht		Waga worka Bag weight Gewicht je Beutel		Produkt dostępny na zamówienie Available on request Auf Anfrage

## Rodzaj opakowania / Type of package / Verpackungsart



	Wymiary stosowane/ Dimensions/ Ausmaße (cm) l x w x h
Paleta niska 110 / low pallet 110 / niedrige Palette 110	110 x 110 x 125
Paleta niska 120 / low pallet 120 / niedrige Palette 120	120 x 100 x 125
Paleta wysoka 110 / high pallet 110 / hohe Palette 110	110 x 110 x 180 ÷ 254
Paleta wysoka 120 / high pallet 120 / hohe Palette 120	120 x 100 x 180 ÷ 254
Karton standard / standard carton / Standardkarton	59 x 49 x 42
Karton na haki / carton for hangers/ Hakenkarton	59 x 49 x 40 59 x 49 x 21
Karton na „Classic” / carton for „Classic” / „Classic”- Karton	55 x 55 x 50



**Desch IPP Sp. z o.o.** prowadzi działalność w branży tworzyw sztucznych jako producent doniczek i pojemników dla szkółkarstwa i ogrodnictwa. Spółka działała na rynku od 1991 roku pod nazwą Interplast Plastic Products Sp. z o.o. We wrześniu 2020 jej właścicielem został Desch Plantpak – producent z Niderlandów. Od sierpnia 2022 firma nosi nazwę Desch IPP Sp. z o.o.

Nasze podstawowe wyroby to szeroki asortyment doniczek i pojemników stosowanych do produkcji szkółkarskiej i ogrodniczej o pojemności od 0,08 L do 65 L, który, w zależności od modelu i rozmiarów, znajduje zastosowanie do produkcji kwiatów i roślin ozdobnych, drzew ozdobnych, sadowniczych, niektórych warzyw i owoców.

Firma produkuje pojemniki nadające się do różnych technologii upraw, w tym w pełni zmechanizowanych, prowadzonych zarówno pod osłonami, jak i w kontenerowniach otwartych.

W ofercie znajdują się również donice dekoracyjne przystosowane do ekspozycji na zawieszach (wiszące).

Kolejne grupy wyrobów to szeroka gama tac transportowych do doniczek okrągłych i kwadratowych, wiaderka na kwiaty cięte oraz skrzynki znajdujące zastosowanie do transportu i magazynowania produktów, w tym roślin w doniczkach.

Tradycyjne czarne doniczki coraz częściej są zastępowane kolorowymi, w tym z materiałów w 100% z recyklingu, które ponownie mogą zostać poddane recyklingowi.

Stosowanie nowoczesnych technologii produkcji i wzornictwa pozwala produkować wyroby o wysokim standardzie jakości, które znajdują licznych nabywców na wielu rynkach światowych.



**Desch IPP Sp. z o.o.** is a plastic processing company and a leading manufacturer of flower pots and containers for nurseries and horticulture. The company was operating on the market since 1991 under the name INTERPLAST PLASTIC PRODUCTS. The Dutch company Desch Plantpak became its owner in September 2020. Since August 2022 the name of the company is Desch IPP Sp. z o.o.

Our basic products are: a wide range of flower pots and containers for gardening and plant nurseries with volumes from 0,08 L up to 65 L which, depending on a model and dimensions, are used in a professional growing of flowers and decorative plants, ornamental and fruit – growing trees, as well as some vegetables and fruits.

The company produces pots adjusted to various technologies of plant cultivation, including fully mechanized, both under glass as well as in open fields. Our offer also includes decorative hanging pots and bowls. A whole range of transport trays for square and round flower pots, buckets for cut flowers, plastic crates for transport and storage of products, including plants in flower pots, are the next group of products.

Traditional flower pots in black more often are being replaced by flower pots in colours, including those in 100% from recycled waste collection and recyclable again.

The use of modern manufacture technologies and design enables production of goods of the highest quality standards which attract a variety of Buyers from many markets worldwide.



**Desch IPP Sp. z o.o.** ist eine Kunststoff verarbeitende Firma, Hersteller von Töpfen und Behältern für Baumschulen und Gärtnereien. Das Unternehmen funktionierte seit 1991 unter dem Namen Interplast Plastic Products Sp. z o.o. Im Jahr 2020 bekam es ein Teil von Desch Plantpak und ist seit August 2022 als Desch IPP Sp. z o.o. bekannt.





























Das Sortiment besteht aus Blumentöpfen und Container für Baumschulen und Gärtnereien, in Größen von 0,08 bis 65 Litern. Abhängig vom Model und Abmessung werden die Produkte in der professionellen Zucht von Blumen und Pflanzen, Zier- und Fruchtbäumen, sowie Gemüse und Obst eingesetzt. Desch IPP produziert Töpfe die für verschiedene Anbautechnologien, einschließlich der vollmechanisierten, sowohl in Gewächshäusern als auch beim Anbau im Freien, geeignet sind.

Das Angebot umfasst auch dekorative Töpfe (Ampeln) und Pflanzschalen. Weitere Produktgruppen sind Transport- und Zuchtplatten für runde und eckige Töpfe; Eimer für Schnittblumen und Kisten für den Transport und Lagerung von verschiedenen Produkten, einschließlich Topfpflanzen.

Traditionelle schwarze Töpfe werden zunehmend durch farbigen ersetzt, die vorwiegend aus recycelbaren Materialien bestehen.

Der Einsatz von Maschinen auf dem höchsten technischen Stand und modernes Design ermöglichen die Herstellung von qualitativ hochwertigen Produkten, die von Kunden weltweit eingekauft werden.

# Spis treści / Contents / Übersicht

<b>1</b>	<b>Doniczki kwadratowe / Square pots / Vierecktöpfe</b>	<b>3</b>			
<b>1.1</b>	Kwadratowe wysokie / Tall Square / Viereckig hoch		4		
<b>1.2</b>	Kwadratowe / Square / Viereckig		5		
<b>1.3</b>	VKR donice kwadratowe – okrągłe dno / VKR square pots – round bottom / VKR Viereckig – Rund		6		
<b>1.4</b>	Neva / Tiber		6		
<b>2</b>	<b>Doniczki i pojemniki okrągłe / Round flower-pots and containers / Runde Blumentöpfe und Container</b>	<b>7</b>			
<b>2.1</b>	Małe SB / Small SB / Klein SB		8		
<b>2.2</b>	PBN		8		
<b>2.3</b>	H-KB		8		
<b>2.4</b>	CLN		9		
<b>2.5</b>	KB		9		
<b>2.6</b>	DPY		10		
<b>2.7</b>	Oxygen		10		
<b>2.8</b>	L-LSR		10		
<b>2.9</b>	H-HSR		11		
<b>2.10</b>	H-LSR		11		
<b>2.11</b>	Amazone		12		
<b>2.12</b>	LBCZ		13		
<b>2.13</b>	SBX		14		
<b>2.14</b>	Pojemniki duże / Large containers / Große Container		15		
<b>2.15</b>	Podstawki / Saucers / Schüssel		15		
<b>2.16</b>	RP		16		
<b>2.17</b>	Pojemnik na choinki B 12 / Bucket for Christmas tree B 12 / Weihnachtsbaumeimer B 12		16		
<b>2.18</b>	Pojemniki na kwiaty cięte / Cut flower buckets / Schnittblumeneimer		17		
<b>2.19</b>	Doniczki bezbarwne / Transparent flower-pots / Transparente Blumentöpfe		18		
<b>2.20</b>	Doniczki recyklowalne / Recyclable pots / Recyclingfähige Töpfe		18		
<b>3</b>	<b>Doniczki dekoracyjne / Decorative flower-pots / Dekorative Blumentöpfe</b>	<b>19</b>			
<b>3.1</b>	Classic		20		
<b>3.2</b>	HP LUX		21		
<b>3.3</b>	HP DECOR		22		
<b>3.4</b>	Haki / Hangers / Hanger		24		
<b>4</b>	<b>Tace do transportu i uprawy / Transport and cultivation trays / Transport- und Zuchtplatten</b>		<b>25</b>		
<b>5</b>	<b>Pozostałe / Others / Sonstige</b>		<b>34</b>		

**Doniczki kwadratowe**  
**Square pots**  
**Vierecktöpfe**

**1**

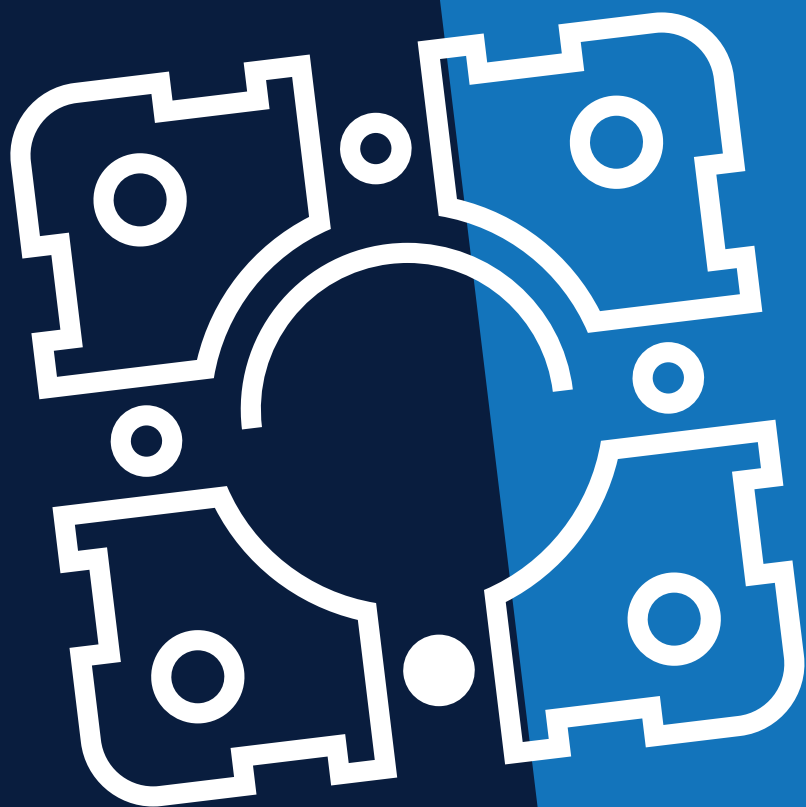















# 1.1 Kwadratowe wysokie / Tall Square / Viereckig hoch

Doniczki kwadratowe / Square pots / Vierecktöpfe

Kolor standardowy / Standard colour / Standardfarben: 

Na zamówienie: inne kolory / Other colours upon request / Sonstige Farben auf Anfrage.



														
<b>9x9x13 H</b>	0,75	9x9	7,0	13	5°	600	24	20	525	9 438	283	—	—	100x120x125
<b>11x11x19 H</b>	1,65	11x11	8,3	19	3,5°	—	—	—	—	4 500	259	—	—	100x120x125
<b>11x11x21,5 H</b>	2	11x11	8,5	21,5	3,5°	—	—	—	—	3 600	265	—	—	100x120x125
<b>11x11x21,5 HM</b>	2	11x11	8,5	21,5	3,5°	—	—	—	—	3 600	265	—	—	100x120x125
<b>13,7x13,7x23H</b>	3	13,7x13,7	10,1	23	5°	—	—	—	—	2 835	318	—	—	100x120x125
<b>15x15x20 H</b>	3,15	15x15	11	20	5°	—	—	—	—	4 592	437	—	—	100x120x125
<b>20x20x23 H</b>	5,7	19,5x19,5	14	23	5°	—	—	—	—	2 040	348	—	—	100x120x125
<b>25x25x26 H</b>	11	25x25	18,6	26	5°	—	—	—	—	1 200	316	—	—	100x120x125
<b>25x25x26 SF</b>	10	25x25	18,9	26	5°	—	—	—	—	840	229	—	—	100x120x125









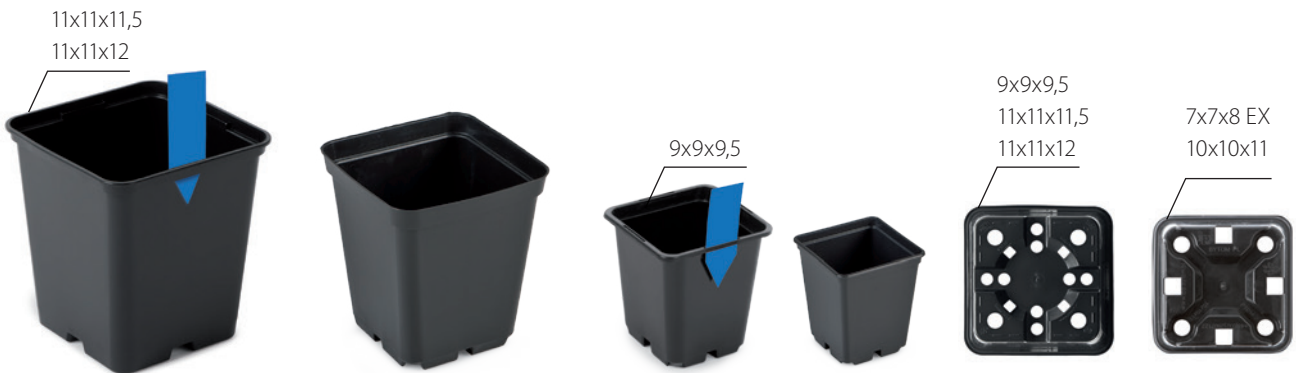
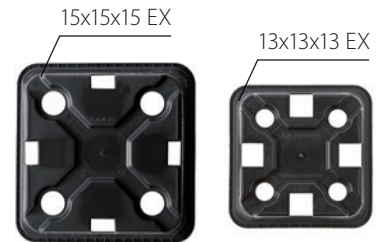





## 1.2 Kwadratowe / Square / Viereckig

Doniczki kwadratowe / Square pots / Vierecktöpfe

Kolor standardowy / Standard colour / Standardfarben:  

Na zamówienie: inne kolory / Other colours upon request / Sonstige Farben auf Anfrage.



														
	?	dm³	cm	cm	cm	cm	cm	kg	(h=2,4m)	kg	cm	(h=1,25m)	kg	cm
<b>7x7x8 EX</b>		0,25	7x7	5,2	7,8	5°	2 688	29	20	560	100x120x240	30 940	330	100x120x125
<b>9x9x9,5</b>		0,5	9x9	6,5	9,6	5°	1 260	25	20	520	100x120x240	18 876	363	100x120x125
<b>10x10x11</b>		0,7	10x10	7,4	11	5°	1 200	30	20	620	100x120x240	14 400	340	100x120x125
<b>11x11x11,5</b>		0,85	10,8x10,8	7,8x7,8	11,5	5°	780	22	20	460	100x120x240	12 870	361	100x120x125
<b>11x11x12</b>		1	11x11	8x8	12	5°	560	17,5	20	370	100x120x240	9 405	282	100x120x125
<b>13x13x13 EX</b>		1,4	13x13	9,5	13	5°	736	30	16	505	100x120x240	7 308	318	100x120x125
<b>15x15x15 EX</b>		2,3	15x15	11,2	15	5°	—	—	—	—	—	4 410	318	110x110x125

### 1.3 VKR donice kwadratowe – okrągłe dno / VKR square pots – round bottom / VKR Viereckig – Rund

Doniczki kwadratowe / Square pots / Vierecktöpfe

Kolor standardowy / Standard colour / Standardfarben:  

Na zamówienie: inne kolory / Other colours upon request / Sonstige Farben auf Anfrage.



	dm³	cm	cm	cm	cm	(h=1,25m)	kg	cm
VKR 1	1,0	11x11	8,3x8,3	12,5	—	10 098	315	100x120x125
VKR 1,4	1,4	12,6x12,6	9x9	13	—	8 208	325	100x120x125
VKR 2	2,0	14x14	11,8	14	—	4 200	227	100x120x125
VKR 2H	2,0	14x14	11,8	15,1	—	3 472	199	100x120x125
VKR 2H – 8G	2,0	14x14	11,8	15,1	—	3 472	199	100x120x125
VKR 3	3,0	15,8x15,8	13,3	16	—	2 520	209	100x120x125
VKR 4	4,0	17,5x17,5	14	18,5	—	2 250	241	100x120x125
VKR 5	5,0	18,5x18,5	14,8	20	—	2 160	268	100x120x125

Szczegółowy opis na stronie  
Detailed description on page  
Einzelheiten auf Seite

36

### 1.4 Neva / Tiber

Doniczki kwadratowe / Square pots / Vierecktöpfe

Kolor standardowy / Standard colour / Standardfarben:  

Na zamówienie: inne kolory / Other colours upon request / Sonstige Farben auf Anfrage.

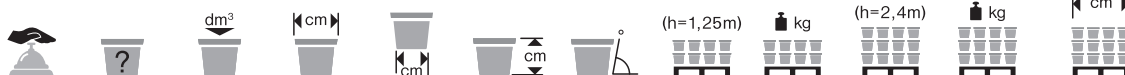
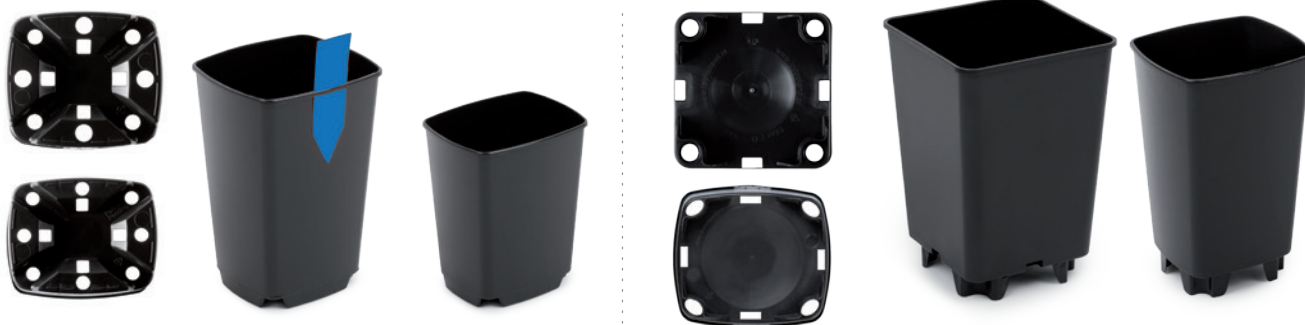

	dm³	cm	cm	cm	cm	(h=1,25m)	kg	(h=2,4m)	kg	cm
✓ Neva 1	0,9	11,3x8,7	8,7 x 6,7	13,5	—	7 700	245	—	—	100x120x125
✓ Neva 2	1,7	12,4x10,9	9,3x8,1	17,0	—	4 536	280	—	—	100x120x125
✓ Tiber 1,8 HV	1,8	12,4x10,9	9,3x8,1	19,0	—	3 078	195	—	—	100x120x125
✓ Tiber 2,4 HV	2,4	13,5x13,5	10,8x10,8	19,5	—	2 520	237	—	—	100x120x125

**Doniczki i pojemniki okrągłe**  
**Round flower-pots and containers**  
**Runde Blumentöpfe und Container**

**2**

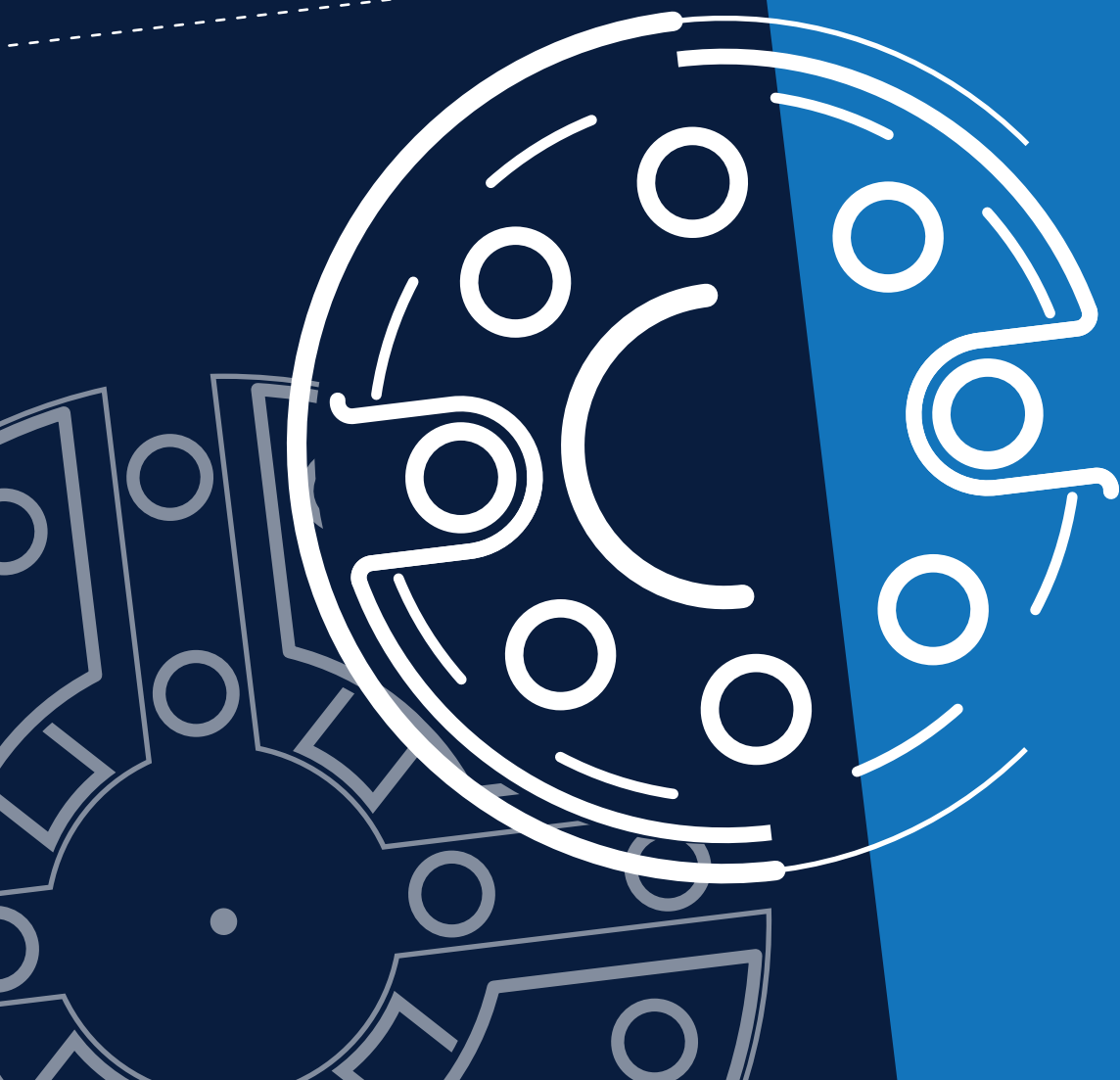















## 2.1 Małe SB / Small SB / Klein SB

Doniczki i pojemniki okrągłe / Round flower-pots and containers / Runde Blumentöpfe und Container

Kolor standardowy / Standard colour / Standardfarben: 

Na zamówienie: inne kolory / Other colours upon request / Sonstige Farben auf Anfrage.



														
<b>SB 5,5</b>	?	0,08	5,5	3,9	5,1	5°	7 035	29	20	600	100x120x240	—	—	—
<b>SB 8</b>	?	0,2	8	6,1	6,3	5°	2 450	21	20	440	100x120x240	49 000	437	100x120x220
<b>8,5</b>	?	0,25	8,5	6,6	6,5	5°	2 200	19,4	20	408	100x120x240	39 000	371	100x120x220









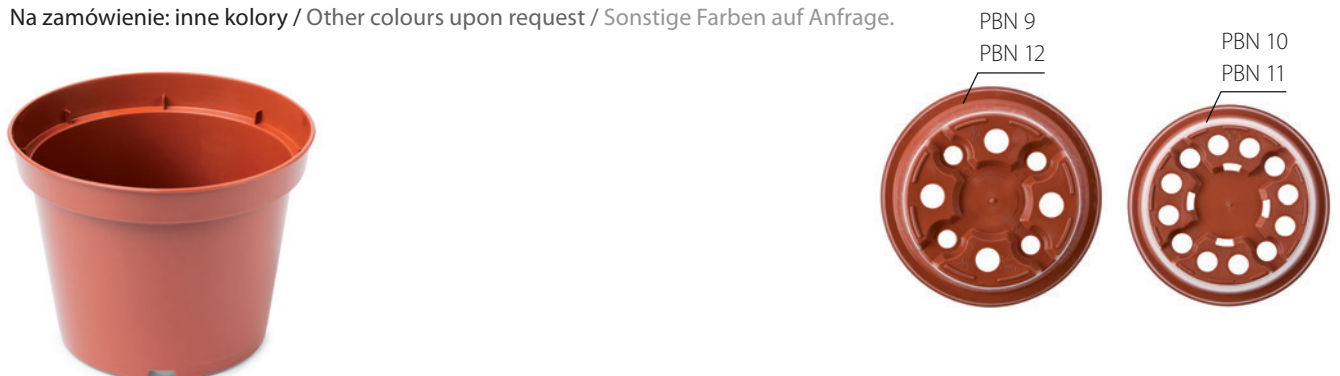





## 2.2 PBN

Doniczki i pojemniki okrągłe / Round flower-pots and containers / Runde Blumentöpfe und Container

Kolor standardowy / Standard colour / Standardfarben: 

Na zamówienie: inne kolory / Other colours upon request / Sonstige Farben auf Anfrage.



															
<b>PBN 9</b>	?	0,25	9	6,3	7	8°	2 240	22,5	20	470	100x120x240	—	393	43 200	100x120x190
<b>PBN 10</b>	?	0,4	10	7	7,5	8°	1 920	26	20	480	100x120x240	—	380	33 000	100x120x200
<b>PBN 11</b>	?	0,45	11	7,7	8	8°	—	—	—	—	—	18 000	290	—	100x120x125
<b>PBN 12</b>	?	0,6	12	8,2	9	8°	—	—	—	—	—	11 900	234	—	110x110x125











## 2.3 H-KB

Doniczki i pojemniki okrągłe / Round flower-pots and containers / Runde Blumentöpfe und Container

Kolor standardowy / Standard colour / Standardfarben: 

Na zamówienie: inne kolory / Other colours upon request / Sonstige Farben auf Anfrage.



										
<b>H 14 KB</b>	✓	?	1,45	14	10,7	13,2	5°	6 528	251	100x120x125
<b>H 15 KB</b>	✓	?	1,7	15	11,5	14,2	5°	5 088	253	100x120x125

## 2.4 CLN

Doniczki i pojemniki okrągłe / Round flower-pots and containers / Runde Blumentöpfe und Container

Kolor standardowy / Standard colour / Standardfarben:  

Na zamówienie: inne kolory / Other colours upon request / Sonstige Farben auf Anfrage.

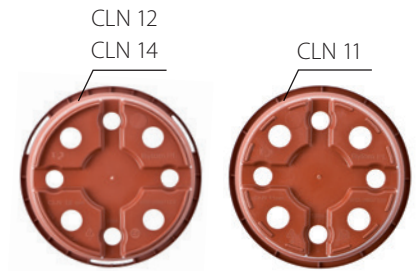

		dm <sup>3</sup>	cm	cm	cm	°		kg	(h=2,4m)	kg	cm	(h=1,25m)	kg	(h=2,4m)	kg	cm
✓	CLN 11	0,5	11	8,4	8,7	5°	—	—	—	—	—	12 600	234	—	—	100x120x125
✓	CLN 12	0,75	12	9,2	9,5	5°	—	—	—	—	—	9 976	230	18 920	441	100x120x125 100x120x240
✓	CLN 14	1,1	14	10,7	10,8	5°	—	—	—	—	—	6 912	260	12 800	443	100x120x125 100x120x240

## 2.5 KB

Doniczki i pojemniki okrągłe / Round flower-pots and containers / Runde Blumentöpfe und Container

Kolor standardowy / Standard colour / Standardfarben:  

Na zamówienie: inne kolory / Other colours upon request / Sonstige Farben auf Anfrage.



Szczegółowy opis na stronie  
Detailed description on page  
Einzelheiten auf Seite

36

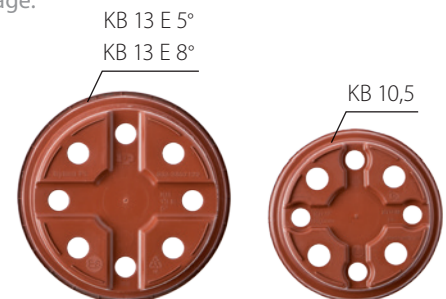

		dm <sup>3</sup>	cm	cm	cm	°		kg	(h=2,4m)	kg	cm	(h=1,25m)	kg	(h=2,4m)	kg	cm
	KB 10,5	0,45	10,5	8,1	7,8	5°	1 250	18,5	20	390	—	—	25 000	370	—	100x120x220
	KB 13 E 5°	0,85	13	10	9,5	5°	—	—	—	—	7 000	195	14 000	370	—	120x100x125 100x120x240
	KB 13 E 8°	0,85	13	9,1	9,5	8°	—	—	—	—	10 920	282	—	—	—	100x120x125















## 2.6 DPY

Doniczki i pojemniki okrągłe / Round flower-pots and containers / Runde Blumentöpfe und Container

Kolor standardowy / Standard colour / Standardfarben: 

Na zamówienie: inne kolory / Other colours upon request / Sonstige Farben auf Anfrage.











																
✓ DPY 9		?	0,3	9	6,8	6,8	5°	1 920	18,7	25	488	—	—	47 520	448	100x120x240
✓ DPY 10,5			0,45	10,5	7,9	7,8	5°	1 300	15,5	20	336	—	—	32 175	374	100x120x240
✓ DPY 11			0,5	10,5	7,8	8,8	5°	1 300	19,7	20	414	—	—	32 175	470	100x120x240
✓ DPY 12			0,7	12	8,9	9	5°	1 000	17,5	20	370	—	—	25 800	433	100x120x240
✓ DPY 13			0,85	13	9,5	9,5	5°	800	17	20	360	—	—	20 400	418	100x120x240
✓ DPY 14			1	14	9,7	11,6	8°	640	16,8	20	356	—	—	19 200	481	100x120x240

## 2.7 Oxygen

Doniczki i pojemniki okrągłe / Round flower-pots and containers / Runde Blumentöpfe und Container



									
OXYGEN		0,80	11,5	8,5	10,2	—	6 160	147	100x120x125









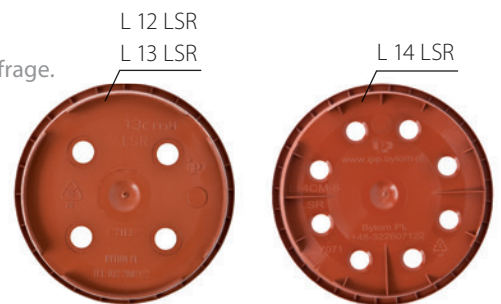

## 2.8 L-LSR

Doniczki i pojemniki okrągłe / Round flower-pots and containers / Runde Blumentöpfe und Container

Kolor standardowy / Standard colour / Standardfarben:  

Na zamówienie: inne kolory / Other colours upon request / Sonstige Farben auf Anfrage.



										
L 12 LSR		0,7	12	9,3	9,5	5°	4	9 350	244	110x110x125
L 13 LSR		0,9	13	10	10,5	5°	4	6 800	238	110x110x125
L 14 LSR		1,15	14	10,8	11,5	5°	8	6 720	255	100x120x125











## 2.9 H-HSR

Doniczki i pojemniki okrągłe / Round flower-pots and containers / Runde Blumentöpfe und Container

Kolor standardowy / Standard colours / Standardfarben: 

Na zamówienie: inne kolory / Other colours upon request / Sonstige Farben auf Anfrage.



										
<b>H 11 HSR</b>	?	0,6	11	8,3	10	5°	4	11 550	263	100x120x125
<b>H 19 HSR</b>	?	3,15	19	14,3	18,1	5°	12	1 920	164	110x110x125
<b>H 21 HSR</b>	?	4,5	21	16	19	5°	6	1 950	225	100x120x125













## 2.10 H-LSR

Doniczki i pojemniki okrągłe / Round flower-pots and containers / Runde Blumentöpfe und Container

Kolor standardowy / Standard colour / Standardfarben: 

Na zamówienie: inne kolory / Other colours upon request / Sonstige Farben auf Anfrage.



												
<b>H 24 LSR</b>	7	24	18,3	22	5°	12	1 200	218	—	—	110x110x125	
<b>H 27 LSR</b>	10	27	20,5	25	5°	12	864	232	—	—	110x110x125	
<b>H 30 LSR</b>	14	30	23,3	27,5	5°	12	644	252	—	—	100x120x125	
							—	—	1 288	484	100x120x210	

















## 2.11 Amazone

Doniczki i pojemniki okrągłe / Round flower-pots and containers / Runde Blumentöpfe und Container

Kolor standardowy / Standard colour / Standardfarben: 

Na zamówienie: inne kolory / Other colours upon request / Sonstige Farben auf Anfrage.



																	
<b>Amazone 11</b>	?	0,6	11	8,4	10,1	5°	—	—	—	—	—	—	—	20 400	335	100x120x210	
<b>Amazone 12</b>	?	0,8	12	9,1	11,1	5°	—	—	—	—	9 500	260	—	—	18 920	490	100x120x120 100x120x230
<b>Amazone 13</b>	?	1	13	9,8	12,1	5°	—	—	—	—	—	—	—	12 240	400	100x120x210	
<b>Amazone 14</b>	?	1,3	14	10,6	13,0	5°	—	—	—	—	4 770	191	—	—	—	100x120x120	
<b>Amazone 15</b>	?	1,7	15	11,4	14,0	5°	—	—	—	—	4 800	245	—	—	—	100x120x120	
<b>Amazone 17</b>	?	2,7	17	13,0	15,5	5°	—	—	—	—	3 520	220	—	—	—	100x120x120	
<b>Amazone 19</b>	?	3,4	19	14,4	17,8	5°	—	—	—	—	2 700	230	—	—	—	100x120x120	
<b>Amazone 21</b>	?	4,7	21	16,0	19,6	5°	—	—	—	—	1 650	215	—	—	—	100x120x120	
<b>Amazone 24</b>	?	7,0	24	18,3	22,6	5°	—	—	—	—	1 150	210	—	—	—	100x120x120	
<b>Amazone 27</b>	?	10,0	27	20,5	25,2	5°	—	—	—	—	—	912	225	—	—	100x120x120	

## 2.12 LBCZ

Doniczki i pojemniki okrągłe / Round flower-pots and containers / Runde Blumentöpfe und Container

Seria niskich donic produkcyjnych LBCZ o pojemnościach od 2 do 25 litrów (10 modeli) została zaprojektowana przede wszystkim dla produkcji roślin o płytkim systemie korzeniowym. Donice zaopatrzone są w otwory poziome w dnie oraz pionowe w ściankach bocznych.

The „low” LBCZ container series, with capacities between 2 till 25 litres (10 models) has mainly been developed for plants with a spreading rooting system. The containers all have horizontal base holes and vertical side slits.

Die „niedrige” LBCZ Containerserie mit Volumen von 2 bis hin zu 25 Litern (10 Modelle) wurde vor allem für Pflanzen mit einem breiten Wurzelsystem entworfen. Die Container sind mit horizontalen Bodenlöchern und vertikalen Seitenschlitzen versehen.

Kolor standardowy / Standard colour / Standardfarben: 









Na zamówienie: inne kolory / Other colours upon request / Sonstige Farben auf Anfrage.

LBCZ 2 ÷ 5



LBCZ 7,5 ÷ 25



									
<b>LBCZ 2</b>	2	17,5	14,1	11,2	5°	4 680	254	110x110x125	
<b>LBCZ 3</b>	3	20	15,9	12,7	5°	3 600	261	110x110x125	
<b>LBCZ 4</b>	4	22	17,2	14,3	5°	2 300	213	100x120x125	
<b>LBCZ 5</b>	5	23,7	18,5	15,4	5°	1 800	200	100x120x125	
<b>LBCZ 7,5L</b>	7,5	27	21,1	17,6	5°	1 520	248	100x120x125	
<b>LBCZ 10</b>	10	30	23,2	19,4	5°	1 020	224	110x110x125	
<b>LBCZ 12</b>	12	32	24,7	20,7	5°	900	263	110x110x125	
<b>LBCZ 15</b>	15	34	26,5	22,2	5°	666	233	100x120x125	
<b>LBCZ 20</b>	20	38	29,8	24,7	5°	520	238	100x120x125	
<b>LBCZ 25</b>	25	41	31,7	26,5	5°	384	218	100x120x125	

## 2.13 SBX

Doniczki i pojemniki okrągłe / Round flower-pots and containers / Runde Blumentöpfe und Container

Wszystkie pojemniki od SBX 1 do SBX 10 dostępne są w wersji podstawowej oraz w wersji ZZG z zamkniętymi otworami na ścianie zewnętrznej. Pojemniki od SBX 12 do SBX 25 dostępne są tylko w wersji ZZG.









All containers from SBX 1 until 10 litres are available with either a standard base or with closed side holes (type ZZG). All containers from SBX 12 until 25 litres are available in the ZZG version, only.

Alle Container von SBX 1 bis hin zu 10 Litern sind entweder mit Seitenlöchern oder ohne Seitenlöcher (Typ ZZG) erhältlich. Alle Container von SBX 12 bis hin zu 25 Litern sind nur in der ZZG Version erhältlich.

Kolor standardowy / Standard colour / Standardfarben: 

Na zamówienie: inne kolory / Other colours upon request / Sonstige Farben auf Anfrage.



							 (h=1,25m)		
<b>SBX 1</b>	1	13	10,1	10,4	5°	9 800	255	100x120x125	
<b>SBX 1,3</b>	1,3	14	10,6	11,3	5°	8 448	265	100x120x125	
<b>SBX 1,5</b>	1,5	15	11,3	12	5°	6 042	232	100x120x125	
<b>SBX 2</b>	2	17	12,7	13,5	5°	5 040	267	100x120x125	
<b>SBX 2,5</b>	2,5	18	13,4	14,5	5°	3 744	211	100x120x125	
<b>SBX 3</b>	3	19	14,2	15	5°	3 300	225	100x120x125	
<b>SBX 3,5</b>	3,5	20	14,9	16,3	5°	3 300	235	100x120x125	
<b>SBX 4</b>	4	21	15,8	16	5°	2 484	199	110x110x125	
<b>SBX 5</b>	5	23	17,8	18	5°	2 116	257	100x120x125	
<b>SBX 7,5</b>	7,5	26	20,2	20	5°	1 120	188	100x120x125	
<b>SBX 10</b>	10	29	22,5	22	5°	980	231	100x120x125	
<b>SBX 12 ZZG</b>	12	31	22,9	25,5	5°	720	193	100x120x125	
<b>SBX 15 ZZG</b>	15	32,7	24,9	26	5°	600	206	100x120x125	
<b>SBX 20 ZZG</b>	20	36	26,9	29,5	5°	450	200	100x120x125	
<b>SBX 25 ZZG</b>	25	38	28,6	31	5°	360	215	100x120x125	

## 2.14 Pojemniki duże / Large containers / Große Container

Doniczki i pojemniki okrągłe / Round flower-pots and containers / Runde Blumentöpfe und Container

Kolor standardowy / Standard colour / Standardfarben: 











Na zamówienie: inne kolory / Other colours upon request / Sonstige Farben auf Anfrage.



Szczegółowy opis na stronie  
Detailed description on page  
Einzelheiten auf Seite

35



											
<b>BCSX 35</b>	?	35	45,9	35	32	5°	185	177	—	—	100x120x125
<b>H 33 LSR</b>	18	33	23,7	29,5	5°	—	—	495	268	—	110x110x220
<b>H 39 LSR</b>	26	39	29,2	32	5°	—	—	280	300	—	110x110x220
<b>H 46 LSR</b>	45	46	36	33,5	5°	—	—	150	248	—	110x110x210
<b>H 54 LSR</b>	65	54	44	35	5°	—	—	120	338	—	110x110x220

## 2.15 Podstawki / Saucers / Schüssel

Doniczki i pojemniki okrągłe / Round flower-pots and containers / Runde Blumentöpfe und Container





Kolor standardowy / Standard colour / Standardfarben: 

Na zamówienie: inne kolory / Other colours upon request /  
Sonstige Farben auf Anfrage.

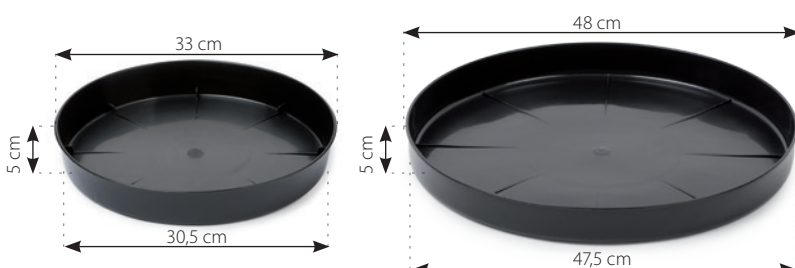
Można zastosować do:  
Suitable for:  
Geeignet für:

H 30 LSR  
H 33 LSR    Ø 33  
H 39 LSR  
H 46 LSR  
H 54 LSR    Ø 48



					
Ø 33	80	14	16	244	110x110x240
Ø 48	30	20,3	16	345	110x110x240

## 2.16 RP









Doniczki i pojemniki okrągłe / Round flower-pots and containers / Runde Blumentöpfe und Container

Kolor standardowy / Standard colour / Standardfarben: 

Na zamówienie: inne kolory / Other colours upon request /

Sonstige Farben auf Anfrage.



									
<b>RP 1</b>	1	11,5	9,6	13,5	5°	6 000	224	100x120x125	
<b>RP 2 ZZG</b>	2	14	10,7	18	5°	4 224	261	100x120x125	
<b>RP 3 ZZG</b>	3	16	11,7	20,5	5°	3 724	355	100x120x125	
<b>RP 4 ZZG</b>	4	18,5	13,1	21,5	5°	3 096	376	100x120x125	
<b>RP 7</b>	7	22	16,4	25,6	5°	1 650	260	100x120x125	









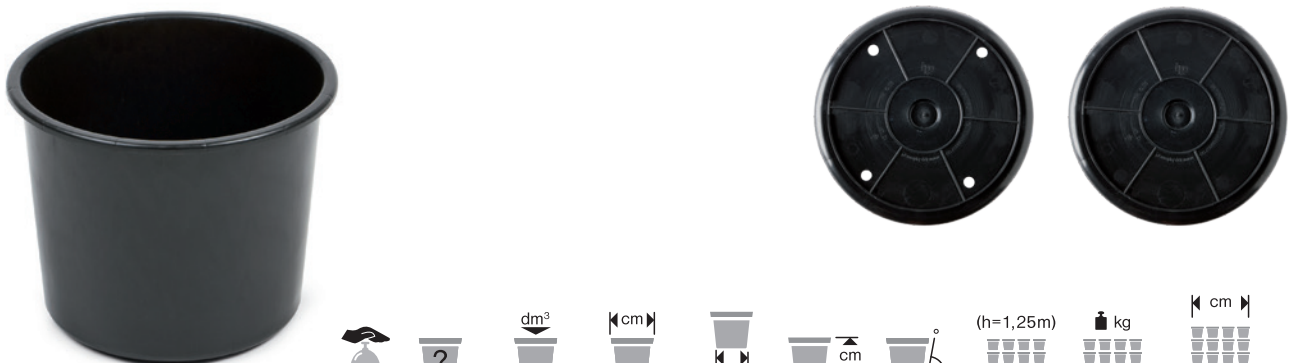

## 2.17 Pojemnik na choinki B 12 / Bucket for Christmas tree B 12 / Weihnachtsbaumeimer B 12

Doniczki i pojemniki okrągłe / Round flower-pots and containers / Runde Blumentöpfe und Container

Kolor standardowy / Standard colour / Standardfarben: 

Na zamówienie: inne kolory / Other colours upon request / Sonstige Farben auf Anfrage.



										
<b>B 12</b>	✓	?	12	30,5	24,5	24	5°	432	210	110x110x125











## 2.18 Pojemniki na kwiaty cięte / Cut flower buckets / Schnittblumeneimer

Doniczki i pojemniki okrągłe / Round flower-pots and containers / Runde Blumentöpfe und Container

Kolor standardowy / Standard colour / Standardfarben: 

Na zamówienie: inne kolory / Other colours upon request / Sonstige Farben auf Anfrage.



											
✓	<b>2 L</b>		2	17	12,7	14,3	5°	4 600	—	277	100x120x125
	<b>3 L</b>		3	18,5	14	17	5°	3 750	—	257	100x120x125
								—	7 500	494	100x120x255
✓	<b>4,5 L</b>		4,5	21,5	16	19,6	5°	—	4 500	481	100x120x250
✓	<b>5 L</b>		5	23	17,5	20	5°	—	4 800	563	100x120x250
	<b>5 L</b> lekki/light		5	23	17,5	20	5°	—	4 800	489	100x120x250
✓	<b>6,5 L</b>		6,5	24,5	18	21	5°	—	3 200	434	100x120x250
	<b>8 L</b> lekki/light		8	26,5	20	21	5°	—	4 140	492	100x120x250
	<b>10 L</b> lekki/light		10	26	18,5	25	5°	—	4 140	598	100x120x250
✓	<b>10 L</b>		10	26	18,5	25	5°	—	4 140	828	100x120x250
✓	<b>W 10 L</b>		10	27,5	21,5	25,5	5°	—	1 875	438	100x120x250
	<b>13 L</b>		13	29	19	35	5°	960	—	337	100x120x125

## 2.19 Doniczki bezbarwne / Transparent flower-pots / Transparente Blumentöpfe

Doniczki i pojemniki okrągłe / Round flower-pots and containers / Runde Blumentöpfe und Container

Na indywidualne zamówienie / Upon Customer's request / auf Anfrage



## 2.20 Doniczki i pojemniki z tworzywa recyklowalnego metodą detekcji NIR (Near Infrared) / Flower-pots and containers made of plastic recyclable by NIR (Near Infrared) detection / Recyclingfähige Töpfe

Doniczki i pojemniki okrągłe / Round flower-pots and containers / Runde Blumentöpfe und Container

Na indywidualne zamówienie / Upon Customer's request / auf Anfrage

W odpowiedzi na rosnące zapotrzebowanie na wyroby z tworzywa w 100 % recyklowalnego oferujemy produkcję pojemników wykonanych z tworzywa PCR (Post Consumer Recycling) pochodzącego w 100% z recyklingu, które może być ponownie poddane recyklingowi metodą detekcji NIR. Oferujemy następujące certyfikowane kolory: szary, terakota, beżowy, antracyt.

In order to fulfil the demand for recyclable pots and containers we offer containers made of PCR (Post Consumer Recycling) received in 100% from recycled waste collection and recyclable again by NIR detection.

We offer the following certified colours: grey, terracotta, taupe, dark antracite.

Um die Anfragen für recyclingfähige Töpfe und Container aus PCR (Post Consumer Recycling) Material zu befriedigen haben wir folgende Farben bei Cyclos zertifizieren lassen, welcher wiederum NIR detektierbar sind: grau, terrakotta, taupe, dunkel anthrazit.



**Doniczki dekoracyjne**  
**Decorative flower-pots**  
**Dekorative Blumentöpfe**

**3**

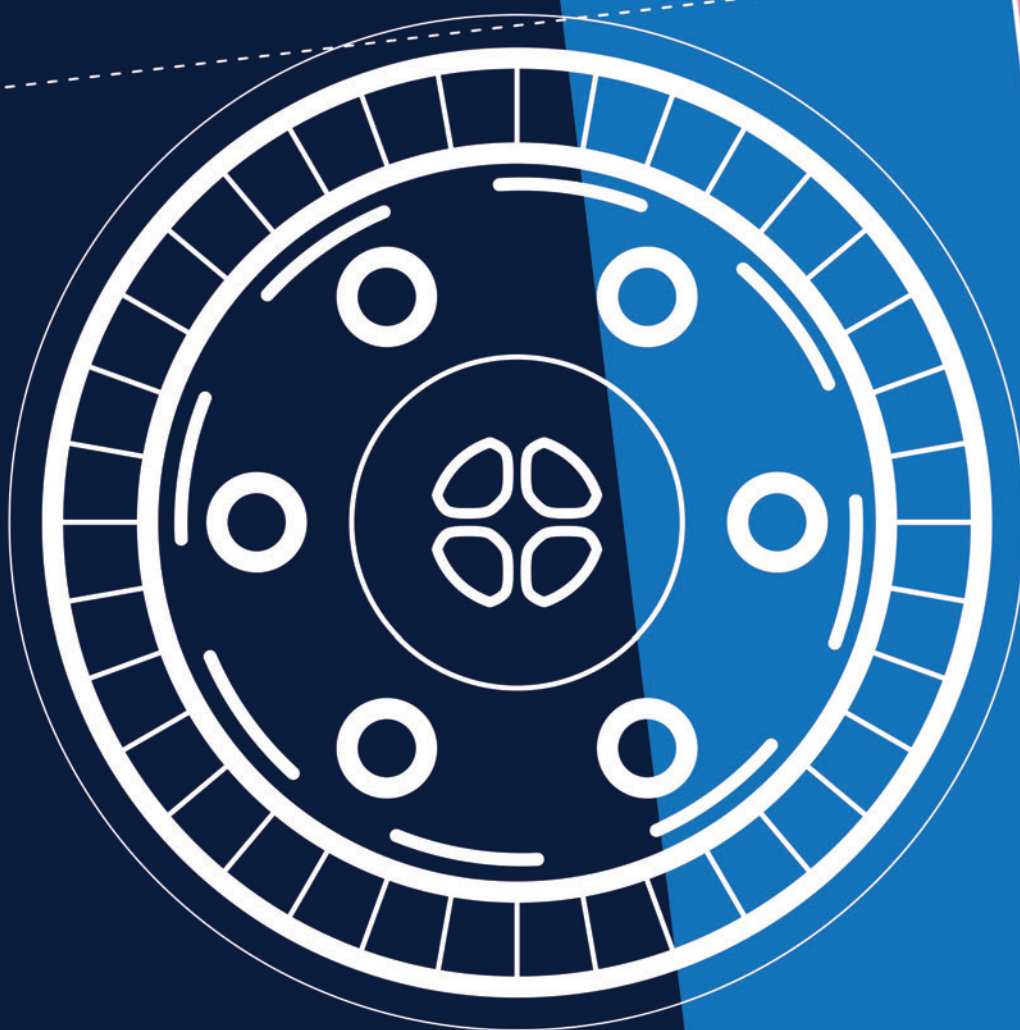

### 3.1 Classic

Doniczki dekoracyjne / Decorative flower-pots / Dekorative Blumentöpfe

Kolor standardowy / Standard colour / Standardfarben:

Na zamówienie: inne kolory / Other colours upon request / Sonstige Farben auf Anfrage.



<b>Classic 1,5</b>	1,5	17	11,8	9	5°	342	17	20	360	100x120x240	4 788	240	110x110x125
<b>Classic 2</b>	2	21,6	14,9	8,6	15°	100	9	20	200	100x120x240	1 450	129	110x110x125
<b>Classic 4</b>	4	26,6	19,1	10,4	15°	96	12	16	228	100x120x240	880	134	110x110x125
<b>Classic 7</b>	7	31,6	23,2	12,4	15°	—	—	—	—	—	660	142	110x110x125
<b>Classic 3 HP</b> <b>Classic 3 HP WR</b>	3	21	15,3	11,1	5°	108	9,5	20	210	100x120x240	1 350	125	110x110x125

## 3.2 HP LUX

Doniczki dekoracyjne / Decorative flower-pots / Dekorative Blumentöpfe

Kolor standardowy / Standard colour / Standardfarben: 

Na zamówienie: inne kolory / Other colours upon request / Sonstige Farben auf Anfrage.

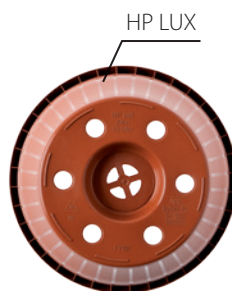

HP LUX

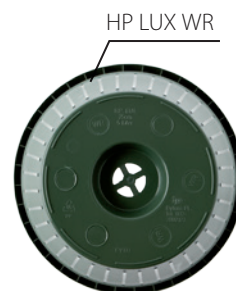

HP LUX WR

### HP LUX WR

Zamknięte dno, zbiornik na wodę wysokości 2 cm (WR).

Closed base: 2 cm water reservoir (WR).

Geschlossener Boden: 2 cm Wasserbehälter (WR).

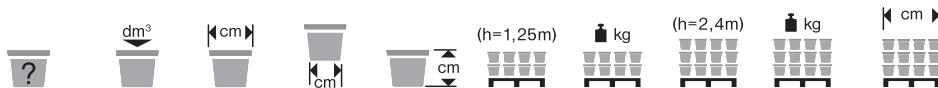

HP LUX 25 HP LUX 25 WR	5	25	16,2	16,2	1 000	150	—	—	110x110x125
---------------------------	---	----	------	------	-------	-----	---	---	-------------













### 3.3 HP DECOR

Doniczki dekoracyjne / Decorative flower-pots / Dekorative Blumentöpfe

Kolor standardowy / Standard colour / Standardfarben: 

Na zamówienie: inne kolory / Other colours upon request / Sonstige Farben auf Anfrage.



												
								(h=2,4m)		(h=1,25m)		
✓	HP Decor 13	0,75	13,0	8,5	9,0	480	13,6	20	292	—	—	110x110x230
✓	HP Decor 14	0,9	14,0	9,0	9,5	—	—	—	—	3 740	165	100x120x115
✓	HP Decor 15	1,2	15,0	10,0	10,0	—	—	—	—	3 087	160	100x120x115
✓	HP Decor 17	1,6	17,0	10,5	12,0	—	—	—	—	2 128	160	100x120x115
✓	HP Decor 19	2,1	19,0	11,5	13,0	—	—	—	—	1 980	190	100x120x115
✓	HP Decor 21	3,0	21,0	13,0	14,5	—	—	—	—	1 175	160	100x120x115
✓	HP Decor 24	4,5	24,0	15,0	16,5	—	—	—	—	820	178	100x120x115
	HP Decor 27 HP Decor 27 WR	7,0	27,0	16,1	18,5	—	—	—	—	800	164	110x110x125
	HP Decor 30 HP Decor 30 WR	7,75	30,0	16,1	19	—	—	—	—	648	146	100x120x125



HP Decor WR

Zamknięte dno, zbiornik na wodę wysokości 2 cm (WR).

Closed base: 2 cm water reservoir (WR).

Geschlossener Boden: 2 cm Wasserbehälter (WR).

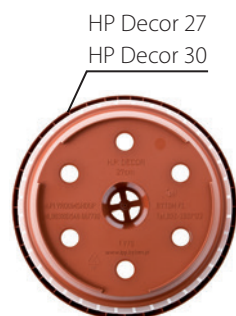

HP Decor 27  
HP Decor 30



HP Decor 27 WR  
HP Decor 30 WR



HP Decor 13, 14, 15, 17, 19, 21, 24



**Podstawka HP Decor / Saucer HP Decor / Schüssel HP Decor 27/30**



				kg	(h=2,4m)	kg	kg	cm
✓	HP 13 cm	960	6	20	140	110x110x210		
✓	HP 14 cm	1496	10	20	220	110x110x230		
✓	HP 15 cm	1032	10	20	220	110x110x230		
✓	HP 17 cm	860	11	20	240	110x110x230		
✓	HP 19 cm	660	13	20	280	110x110x230		
✓	HP 21 cm	470	13	20	280	110x110x230		
✓	HP 24 cm	328	11	20	240	110x110x230		
	HP 27/30 cm	400	17	16	292	110x110x240		

### 3.4 Haki / Hangers / Haken

Doniczki dekoracyjne / Decorative flower-pots / Dekorative Blumentöpfe

Kolor standardowy / Standard colour / Standardfarben:

Na zamówienie: inne kolory / Other colours upon request / Sonstige Farben auf Anfrage.

Można zastosować do: HP LUX  
Suitable for: HP Decor  
Geeignet für: Classic 3 HP

		(L) cm		kg	(h=2,4m) 	kg	cm
S40		40	400	12	20	260	110x110x220
S46		46	400	13	20	280	110x110x220
S52		52	400	15	20	320	110x110x220

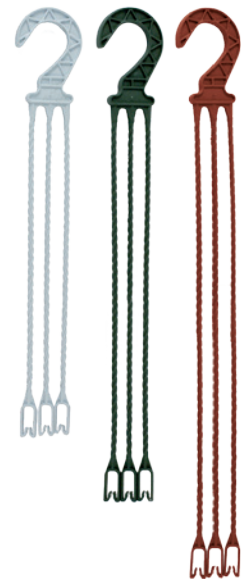

		(L) cm		kg	(h=2,4m) 	kg	cm
HP-26		26	1000	8	36	313	100x120x240
HP-36		36	700	9	36	349	100x120x240
HP-46		46	400	8	36	288	100x120x240



**Tace do transportu i uprawy**  
**Transport and cultivation trays**  
**Transport- und Zuchtplatten**

**4**

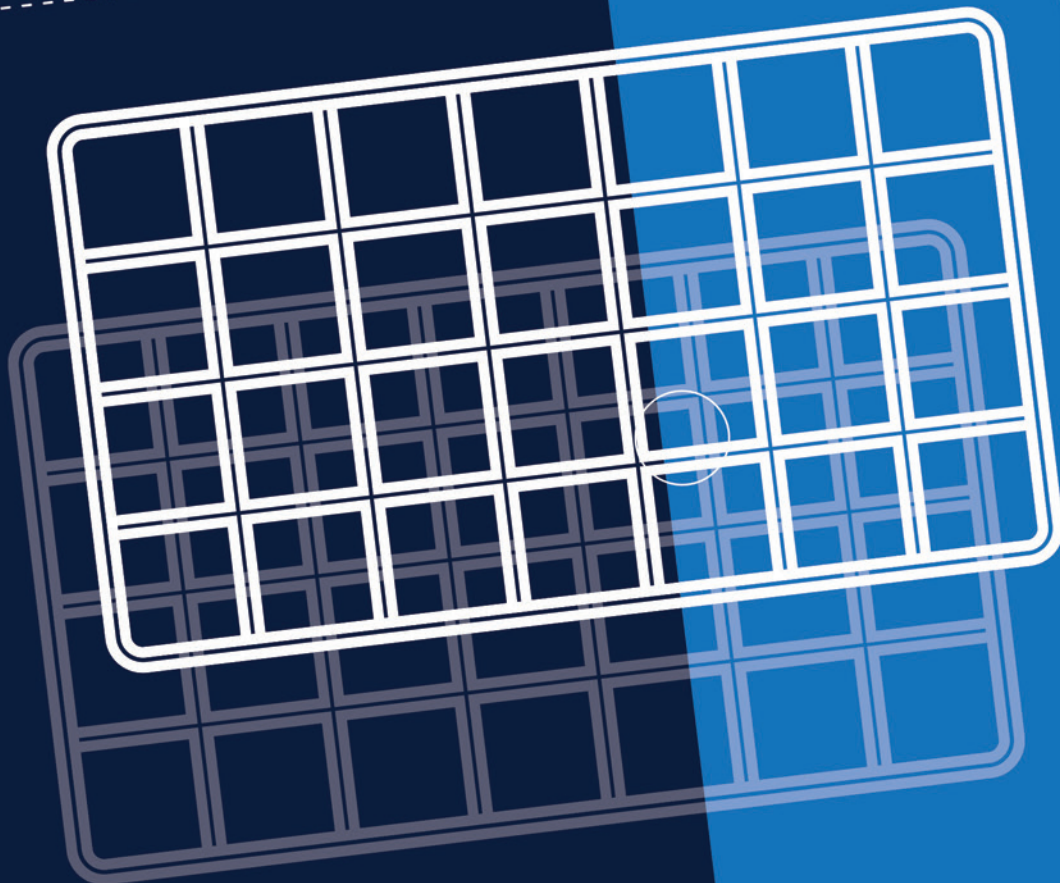

### 4.1 28 x 7 cm x 7 cm / PT 001

Tace do transportu i uprawy / Transport and cultivation trays / Transport- und Zuchtplatten

7x7x8EX



PT 001	28 x 7cm x 7cm	1 330	274	100x120x220

### 4.2 28 x 7cm x 7cm / NR.001

Tace do transportu i uprawy / Transport and cultivation trays / Transport- und Zuchtplatten

7x7x8EX

Nadaje się do podnoszenia widłowego  
Suitable for forklift  
Gabelstapler geeignet

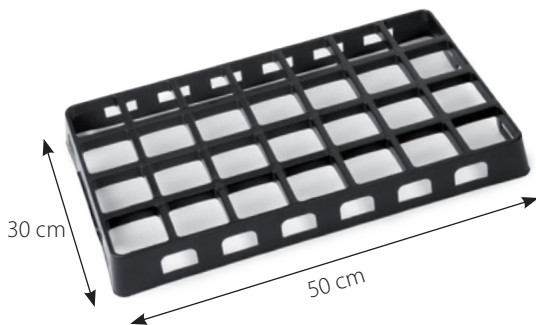

NR.001 SP	28 x 7cm x 7cm	1 120	315	100x120x225

### 4.3 18 x 9cm x 9cm / PT002

Tace do transportu i uprawy / Transport and cultivation trays / Transport- und Zuchtplatten

9x9x13 H  
9x9x9,5

Nadaje się do podnoszenia widłowego  
Suitable for forklift  
Gabelstapler geeignet

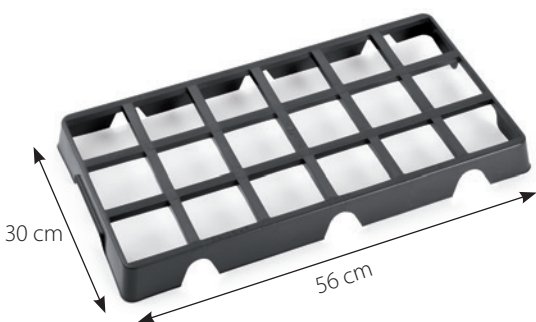

Można również zastosować do: | Ø 8,5 cm  
Also suitable for: | Ø PBN 9 cm  
Auch geeignet für:



PT002	18 x 9cm x 9cm	1 312	319	100x120x220

#### 4.4 24 x 9cm x 9cm / FV122

Tace do transportu i uprawy / Transport and cultivation trays / Transport- und Zuchtplatten

9x9x13 H  
9x9x9,5



Można również zastosować do:  
Also suitable for:  
Auch geeignet für:

Ø 8,5 cm  
Ø PBN 9 cm



FV122	24 x 9cm x 9cm	550	193	100x120x240

#### 4.5 24 x 9cm x 9cm / FV 369

Tace do transportu i uprawy / Transport and cultivation trays / Transport- und Zuchtplatten

9x9x13 H  
9x9x9,5

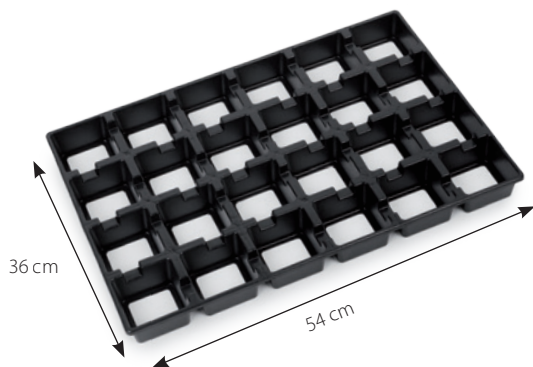

Można również zastosować do:  
Also suitable for:  
Auch geeignet für:

Ø 8,5 cm  
Ø PBN 9 cm



FV 369	24 x 9cm x 9cm	968	364	100x120x230

#### 4.6 10 x 10cm x 10cm / PT024

Tace do transportu i uprawy / Transport and cultivation trays / Transport- und Zuchtplatten

10x10x11

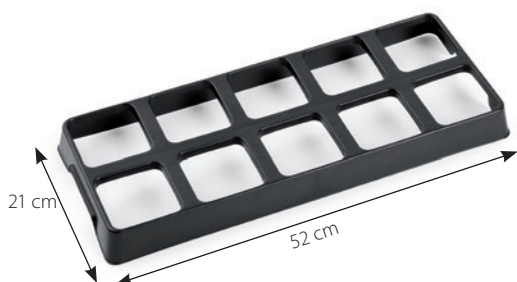

Można również zastosować do:  
Also suitable for:  
Auch geeignet für:

Ø PBN 10 cm  
Ø CLN 10 cm



PT024	10 x 10cm x10 cm	1 980	352	100x120x234

#### 4.7 15 x 10cm x 10cm / FV 249

Tace do transportu i uprawy / Transport and cultivation trays / Transport- und Zuchtplatten

10x10x11

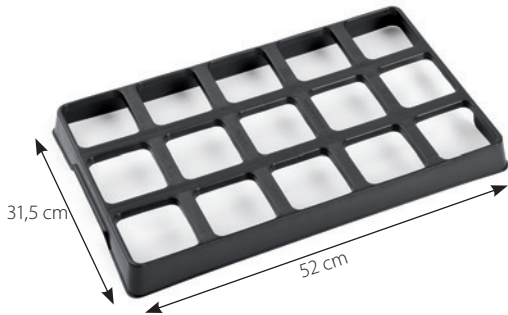

Można również zastosować do:  
Also suitable for:  
Auch geeignet für:

Ø PBN 10 cm



<b>FV 249</b>	15 x 10cm x 10cm	1 320	276	100x120x229

#### 4.8 15 x 11cm x 11cm / PT010

Tace do transportu i uprawy / Transport and cultivation trays / Transport- und Zuchtplatten

11x11x12  
11x11x19 H  
11x11x21,5 H  
VKR 1



Można również zastosować do:  
Also suitable for:  
Auch geeignet für:

10x10x11  
Ø RP 1  
Ø PBN 10 cm  
Ø KB 10,5 cm



<b>PT010</b>	15 x 11cm x 11cm	1 266	291	100x120x212

#### 4.9 10 x 11cm x 11cm / 529

Tace do transportu i uprawy / Transport and cultivation trays / Transport- und Zuchtplatten

11x11x21,5  
11x11x19  
11x11x12  
VKR 1

Dostępne 3 warianty dna  
Available 3 options of bottom  
3 Bodentypen

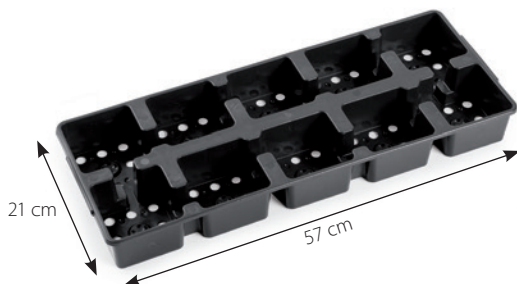

<b>529</b>	10 x 11cm x 11cm	630	230	100x120x220

## 4.10 10 x 11cm x 11cm / 529-3-V

Tace do transportu i uprawy / Transport and cultivation trays / Transport- und Zuchtplatten

Nadaje się do podnoszenia widłowego  
Suitable for forklift  
Gabelstapler geeignet



11x11x21,5  
11x11x19  
11x11x12  
VKR 1

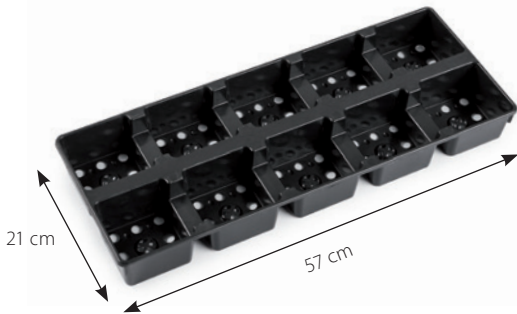

529-3-V	10 x 11cm x 11cm	630	230	100x120x223

## 4.11 10 x 11cm x 11cm / 621

Tace do transportu i uprawy / Transport and cultivation trays / Transport- und Zuchtplatten

Dostępny 2 warianty dna  
Available 2 options of bottom  
2 Bodentypen

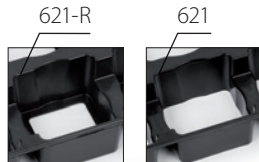

11x11x21,5  
11x11x19  
11x11x12  
VKR 1  
ø Amazone 11



Nadaje się do podnoszenia widłowego  
Suitable for forklift  
Gabelstapler geeignet



621	10 x 11cm x 11cm	676	228	120x100x240

## 4.12 15 x ø 10,5cm / PT009

Tace do transportu i uprawy / Transport and cultivation trays / Transport- und Zuchtplatten

ø KB 10,5

Nadaje się do podnoszenia widłowego  
Suitable for forklift  
Gabelstapler geeignet

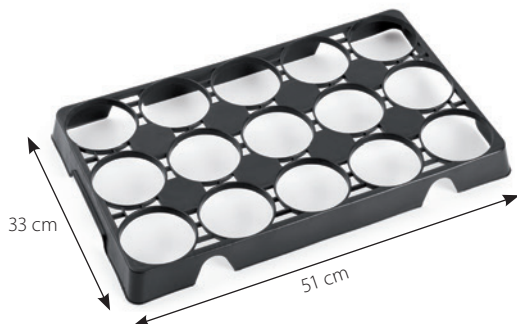

Można również zastosować do:  
Also suitable for:  
Auch geeignet für:

ø PBN 10 cm



PT009	15 x ø 10,5cm	1 368	295	100x120x223

### 4.13 12 x Ø 11/12cm / 4868 / 4868-S

Tace do transportu i uprawy / Transport and cultivation trays / Transport- und Zuchtplatten

Ø CLN 11 cm  
 Ø PBN 11 cm  
 Ø CLN 12 cm  
 Ø PBN 12 cm  
 Ø Amazone 11  
 Ø Amazone 12

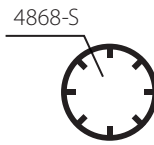

Można również zastosować do: Ø KB 10,5 cm  
 Also suitable for: Ø H 12 S  
 Auch geeignet für:



	kg	cm
<b>4868</b>	12 x Ø 12cm	600
✓ <b>4868-S</b>	12 x Ø 11cm	600
	244	100x120x215
	244	100x120x215

### 4.14 15 x 11cm x 11cm / NP 08

Tace do transportu i uprawy / Transport and cultivation trays / Transport- und Zuchtplatten

VKR 1

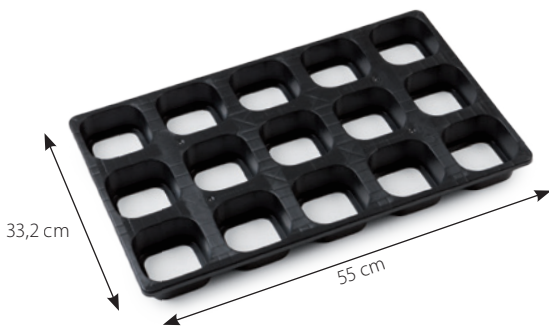

	kg	cm
<b>NP08</b>	15 x 11cm x 11cm	948
	325	100x120x253

### 4.15 10 x Ø 12cm / 569

Tace do transportu i uprawy / Transport and cultivation trays / Transport- und Zuchtplatten

Ø Amazone 11  
 Ø PBN 11  
 VKR 1  
 11x11x12



	kg	cm
<b>569</b>	10 x Ø 12cm	976
	382	100x120x233

### 4.16 15 x ø 12cm / FV 396

Tace do transportu i uprawy / Transport and cultivation trays / Transport- und Zuchtplatten

Nadaje się do podnoszenia widłowego  
Suitable for forklift  
Gabelstapler geeignet

ø Amazone 12  
ø CLN 12  
ø PBN 12



FV 396	15 x ø 12cm	625	277	100x120x220

### 4.17 8 x 12,6 cm x 12,6 cm / NP-11

Tace do transportu i uprawy / Transport and cultivation trays / Transport- und Zuchtplatten

VKR 1,4  
ø CLN 12  
ø KB 13E 8°  
ø Amazone 12

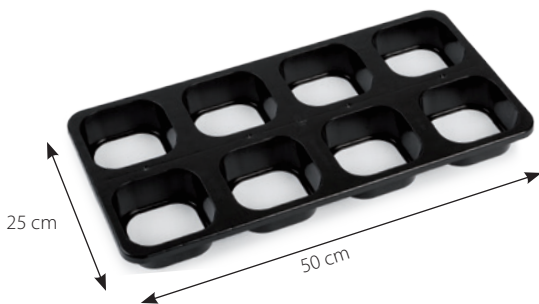

NP-11	8 x 12,6cm x 12,6cm	1 592	368	100x120x220

### 4.18 6 x 14cm x 14cm / NP 04

Tace do transportu i uprawy / Transport and cultivation trays / Transport- und Zuchtplatten

VKR 2  
VKR 2H  
13,7x13,7x23 H  
ø Amazone 14

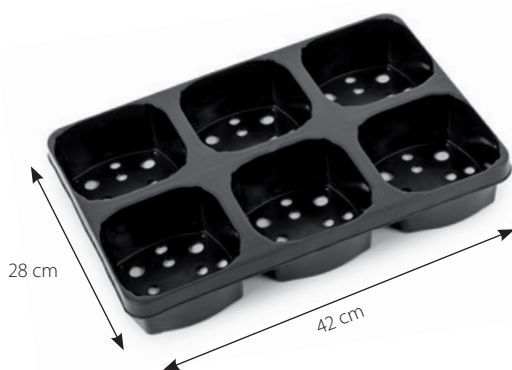

NP 04	6 x 14cm x 14 cm	625	259	100x120x230

### 4.19 8x 14cm x14cm / NP 09

Tace do transportu i uprawy / Transport and cultivation trays / Transport- und Zuchtplatten

**VKR 2**  
**VKR 2H**  
**RP 2**  
**CLN 14**  
**13,7x13,7x23 H**  
**ø Amazone 14**

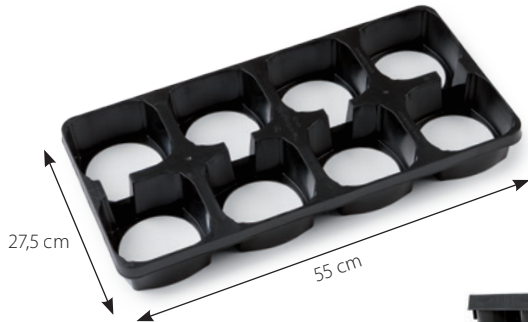

<b>NP 09</b>	8 x 14cm x 14 cm	456	225	100x120x220

### 4.20 6 x ø 14cm / FV 267

Tace do transportu i uprawy / Transport and cultivation trays / Transport- und Zuchtplatten

**ø SBX 1,3**  
**ø H 14 KB**  
**ø Amazone 14**  
**ø CLN 14**  
**RP 2**

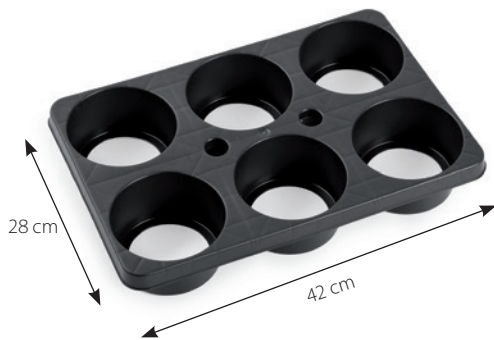

<b>FV 267</b>	6 x ø 14cm	1 462	391	100x120x242

### 4.21 6 x ø 15 cm / NP-10

Tace do transportu i uprawy / Transport and cultivation trays / Transport- und Zuchtplatten

Nadaje się do podnoszenia widłowego  
 Suitable for forklift  
 Gabelstapler geeignet

**ø 15 cm**  
**ø RP 3,0**  
**ø SBX 1,5**  
**ø Amazone 15**







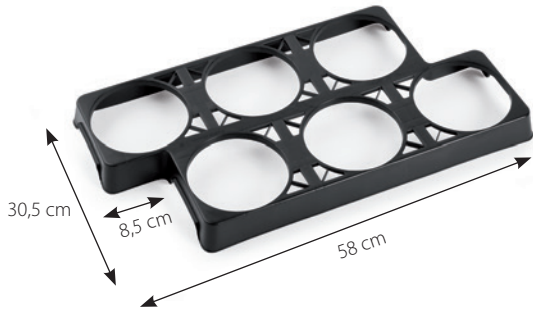

<b>NP-10</b>	6 x ø 15cm	651	233	100x120x220

## 4.22 6 x ø 17cm / PT011

Tace do transportu i uprawy / Transport and cultivation trays / Transport- und Zuchtplatten

ø SBX 2  
ø SBX 1,5



			 kg	 cm
<b>PT011</b>	6 x ø 17cm	1 200	265	100x120x215

# 5

Pozostałe  
Others  
Sonstige

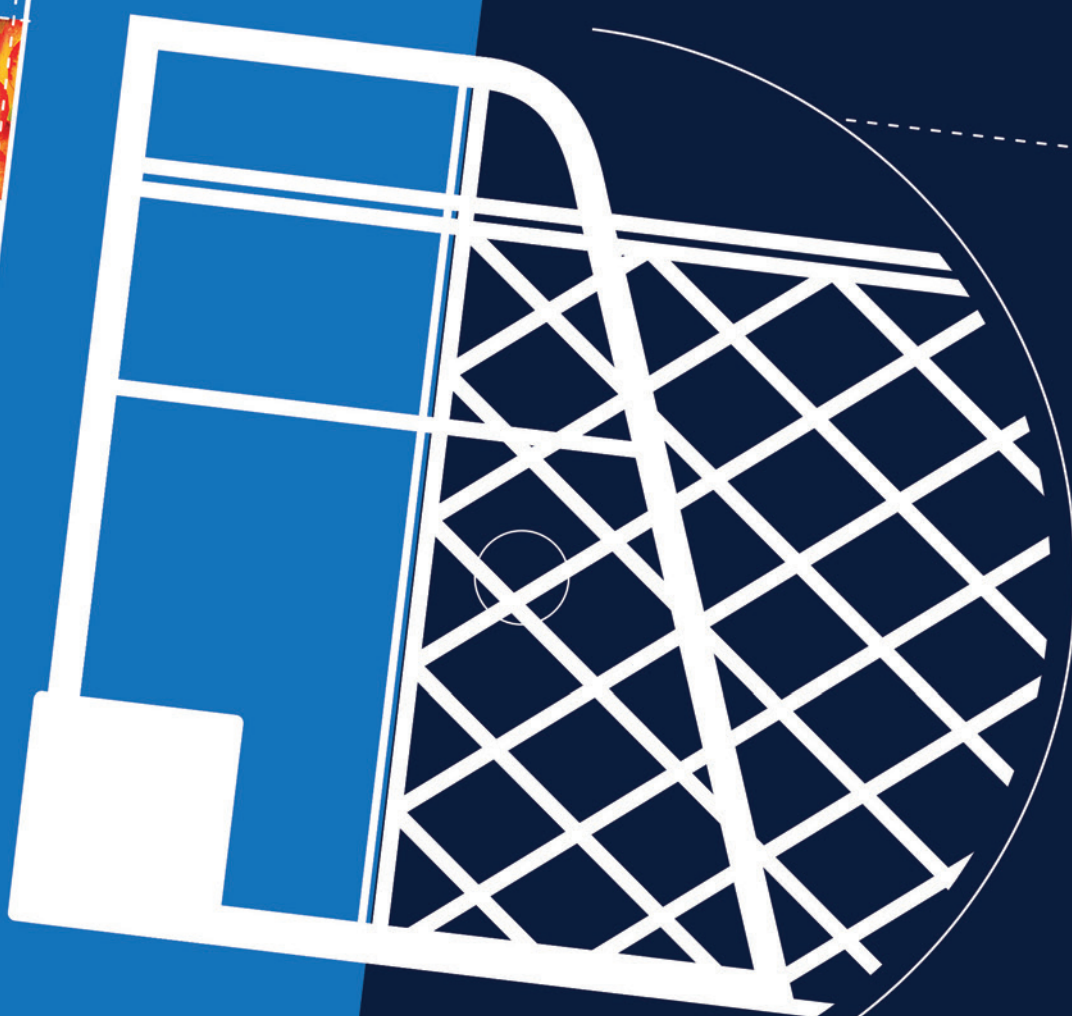

## 5.1 Skrzynki / Crates / Kisten

Skrzynki i podesty / Crates and floor tiles / Kisten und Podeste

Do transportu i magazynowania owoców, warzyw, art. spożywczych, roślin i innych wyrobów. Odporne na działanie niskich temperatur, promieni UV. Kolory według zamówienia klienta.

For the transport and storage of fruits, vegetables, foods, plants and such. Low temperature and UV-resistant. Colours upon request.

Für den Transport und Lagerung von Früchten, Gemüse, Lebensmitteln, Pflanzen usw. Kälte- und UV-beständig.

Farben auf Anfrage.

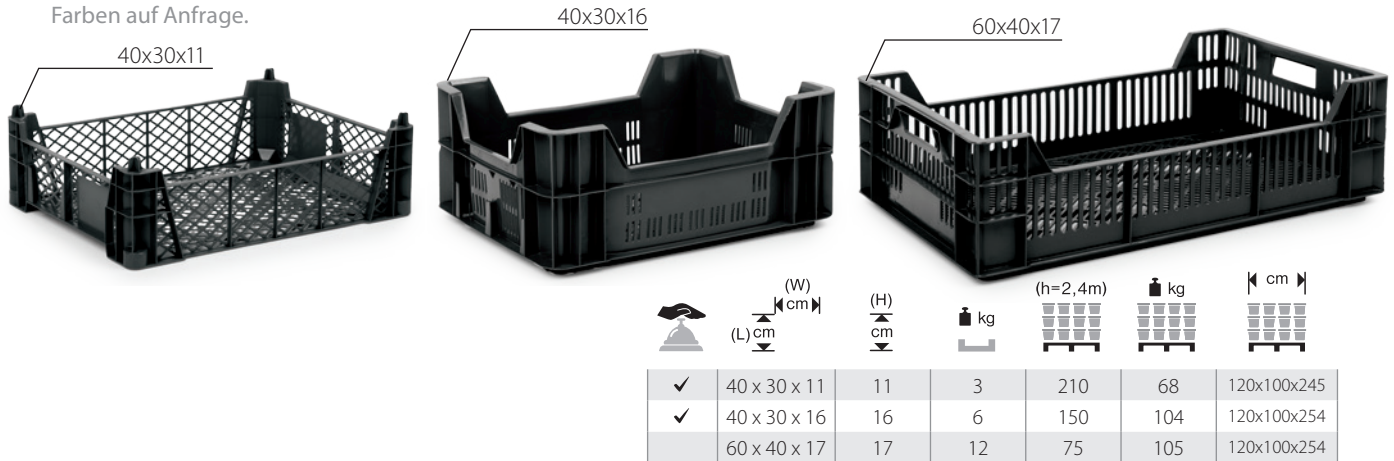

## 5.2 Podesty / Floor tiles / Podeste

Skrzynki i podesty / Crates and floor tiles / Kisten und Podeste

Zastosowanie: jako podesty sanitarne, np. w przemyśle spożywczym, w mokrych pomieszczeniach (baseny itp.); jako podesty chodnikowe, np. ścieżki i tarasy ogrodowe. Właściwości: łatwe do czyszczenia, montażu i demontażu, odporne na działanie temperatur od -20°C do +60°C, odporne na złamania i ścieranie oraz działanie soli i kwasów.

Applications: sanitary floors f.i. food industry, wet areas (swimming pools etc.); decking (garden paths, terraces etc.). Features: easy cleaning, easy (dis-)assembling; withstands extreme temperatures (-20°C till +60°C); hard wearing; salt and acids resistant.

Verwendung: als Sanitätspodeste (z.B. in der Lebensmittelindustrie, Schwimmbädern usw.), als Gehwegpodeste, z.B. als Gartenwege und Terrassen. Eigenschaften: Einfache Reinigung, Montage und Demontage, hochtemperaturfest (-20°C bis +60°C), bruch- und verschleißfest, sowie salz- und säurebeständig.



## 5.3 Uchwyt / Handlebar / Handgriff

Aksesoria / Accessories / Zubehör

Kolor standardowy / Standard colour / Standardfarben:

Na zamówienie: inne kolory / Other colours upon request / Sonstige Farben auf Anfrage.



Można zastosować do:  
Suitable for:  
Geeignet für:

H 33 LSR  
H 39 LSR  
H 46 LSR  
H 54 LSR  
BCSX 35

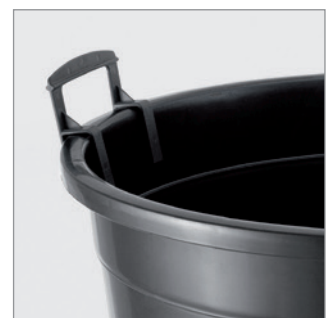

## 5.4 Podstawa do pojemnika / Base for container / Behälterbasis

Aksesoria / Accessories / Zubehör

Podstawa do pojemnika 17-19 cm (2-3 litry). Zabezpiecza roślinę w pojemniku przed przewróceniem i przeschnięciem podczas transportu i ekspozycji (stanowi oddzielny zbiornik wody).







Base for container 17-19 cm (2-3 litres). Prevents the container plants from dehydrating and tipping over during transport and exhibiting (separate water reservoir). Standard colours: black, terracotta. Other colours upon request.

Behälterbasis 17-19 cm (2-3 Liter). Sichert die Containerpflanzen gegen Umkippen und Eintrocknen während des Versands und der Ausstellung (getrennter Wasserbehälter). Standardfarben: schwarz, terrakotta. Sonstige Farben auf Anfrage.

Kolor standardowy / Standard colour / Standardfarben: 

Na zamówienie: inne kolory / Other colours upon request /







Sonstige Farben auf Anfrage.

						
✓	19 cm	26,5x29,5	11	(h=2,4m)	324 kg	110x110x230



## 5.5 Podpora do KB 10,5/ Plant support for KB 10,5 / Pflanzenstutz für KB 10,5



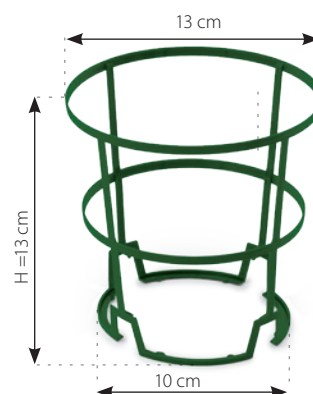

Aksesoria / Accessories / Zubehör

					
✓	520	25	143	(h=2,4m)	100x120x240



## 5.6 Podpora do VKR 2 / Plant support for VKR 2 / Pflanzenstutz für VKR 2

Aksesoria / Accessories / Zubehör

				
✓	150	25	120	(h=2,4m)

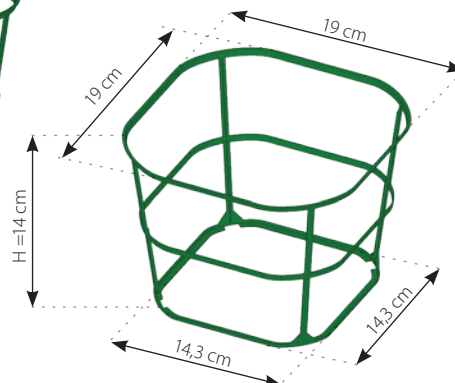





**Desch IPP Sp. z o.o.**

41-923 Bytom, ul. Elektrownia 16  
Poland  
tel.: +48 32 280 71 22  
e-mail: [info@desch-ipp.pl](mailto:info@desch-ipp.pl)  
[www.desch-ipp.pl](http://www.desch-ipp.pl)

**IPP Holland B.V.**

Sluiskil 6, NL-7681 KD, Vroomshoop  
The Netherlands  
Tel.: +31 (0)546-64 72 55/64 70 20  
Fax: +31 (0)546-64 73 45  
e-mail: [info@ippholland.nl](mailto:info@ippholland.nl)  
[www.ippholland.nl](http://www.ippholland.nl)

**Desch Plantpak**

Altenaweg 12, NL-5145PC, Waalwijk  
The Netherlands  
Tel.: +31 (0)416-562 426  
Fax: +31 (0)416-562 288  
e-mail: [information@desch.nl](mailto:information@desch.nl)  
[www.desch.nl](http://www.desch.nl)